



---

**2 Zelig Terra**

**4 Zelig Terra Dimmer**

---

# ZELIG Terra

**Designer**  
Walter Monici - 1990

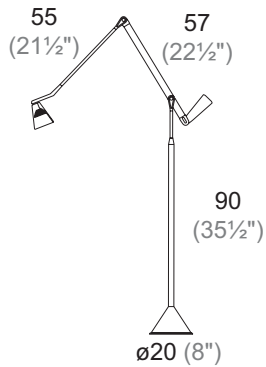

Lampada da terra in alluminio e metallo, braccio estensibile con movimento bilanciato da contrappeso. Base girevole.

Floor lamp of aluminium and metal, adjustable arm pivoting on the base, movement balanced by a counterweight. Rotating base.

Stehleuchte aus Aluminium und Metall. Ausziehbarer Arm mit Bewegung ausgeglichen durch Gegengewicht. Drehbare Fussplatte.



**Col. 01**  
Nero  
Black  
Schwarz







**Col. 02**  
Bianco  
White  
Weiß



**Col. 07**  
Grigio metallizzato  
Metallic grey  
Metallic grau



**Col. 44**  
Nichelato  
Nickled  
Vernickelt

|   |  |
|---|--|
| Denominazione - Name - Name                                 | Zelig Terra (cod. 24)  |
| Certificazioni - Certificated - Prüfzeichen                 |   |
| Normative - Norms - Normen                                  | EN 60-598-1 (CEI 34-21)  |
| Lampadina - Light sources - Leuchtmittel                    |  50W 12V - GY6.35  |
| Versioni - Available - Versionen                            | 230V (Europe) - 120V (USA - Japan) - 240V (England)  |
| Classe di isolamento - Insulation Class - Isolierungsklasse | <b>II</b>  |
| Classe di protezione - Protection Class - Protektionsgrad   | <b>IP20</b>  |
| Imballo - Packaging - Verpackung                            |  1 0,081m <sup>3</sup> - 6,480Kg  |

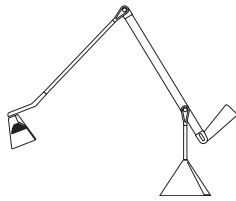

**Cod. 17**  
Zelig

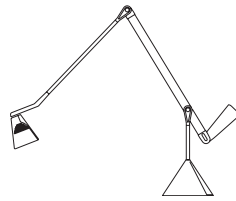

**Cod. 23**  
Zelig Dimmer



**Cod. 26**  
Zelig Terra Dimmer

## Actions

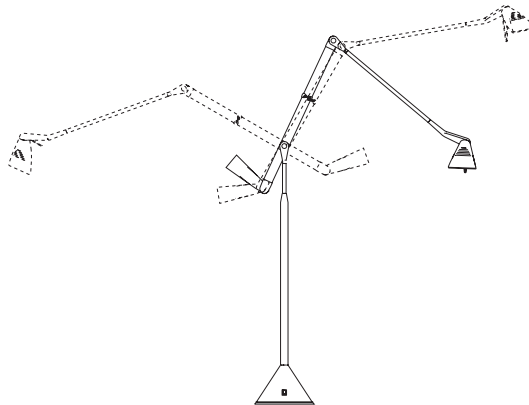

## Notes

---



---



---



---



---



---



---



---

# ZELIG Terra Dimmer

Designer  
Walter Monici - 1990

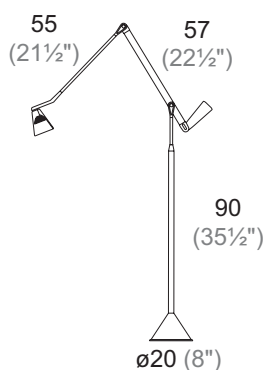

Lampada da terra in alluminio e metallo, con dimmer: braccio estensibile con movimento bilanciato da contrappeso. Base girevole.

Floor lamp of aluminium and metal, with dimmer: adjustable arm pivoting on the base, movement balanced by a counterweight. Rotating base.

Stehleuchte aus Aluminium und Metall, mit Dimmer. Ausziehbarer Arm mit Bewegung ausgeglichen durch Gegengewicht. Drehbare Fussplatte.



**Col. 01**  
Nero  
Black  
Schwarz





**Col. 02**  
Bianco  
White  
Weiß



**Col. 07**  
Grigio metallizzato  
Metallic grey  
Metallic grau



**Col. 44**  
Nichelato  
Nickled  
Vernickelt

|   |   |
|---|---|
| Denominazione - Name - Name                                 | Zelig Terra Dimmer (cod. 26)  |
| Certificazioni - Certificated - Prüfzeichen                 | CE  |
| Normative - Norms - Normen                                  | EN 60-598-1 (CEI 34-21)   |
| Lampadina - Light sources - Leuchtmittel                    | 50W 12V - GY6.35             |
| Versioni - Available - Versionen                            | 230V (Europe) - 120V (USA - Japan) - 240V (England)   |
| Classe di isolamento - Insulation Class - Isolierungsklasse | II  |
| Classe di protezione - Protection Class - Protektionsgrad   | IP20  |
| Imballo - Packaging - Verpackung                            |  0,081m <sup>3</sup> - 6,480Kg |

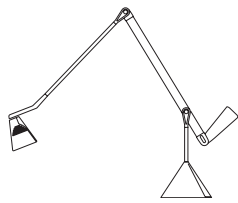

Cod. 17  
Zelig

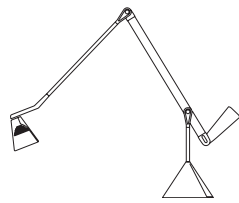

Cod. 23  
Zelig Dimmer

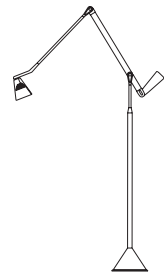

Cod. 24  
Zelig Terra

### Actions

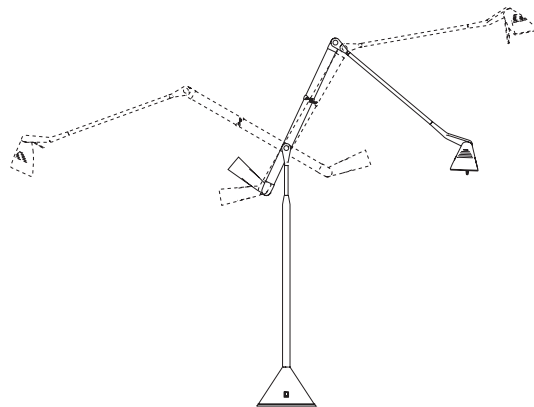

### Notes

---



---



---



---



---



---



---